

Helmet Mounted Night Vision

User Manual

Model: NVG 30

[Catalog]

Safety Guidelines	3
Instructions for Use	3
Products	4
Component Description	5
Charging batteries	6
Battery installed	6
Power on	6
Shutdown	7
Targeted Observations	7
Screen information	7
Automatic mode	8
Motion Mode	8
Menu Operation	8
Detailed introduction of buttons	9
Icon	10
Color	10
Loop recording	11
Playback	11
WIFI	12
Crosshairs	12
IR auto	13
Picture in Picture	13
LCD Brightness Adjustment	14
Date/Time	14
Automatic shutdown	15
Multilingualism	15
Resolution	16
Gyroscope	16
Formatting	17
Default settings	18
Releases	18
Basic parameters	19
Standard configuration	20
Firmware Update	21
Maintenance and cleaning	22
Trouble shooting	21
Maintenance	22
Disposal of waste	22
Precautions for returning goods	22

2

Safety Guidelines

- ⚠️ blinding risk!**
Do not use this product to directly observe strong light sources such as the sun at any time, otherwise it will cause damage to your
- ⚠️ Suffocation!**
Children must use this product under parental supervision. Please put packing materials (such as plastic bags, rubber bands, etc.) keep away from children, otherwise there is a risk of suffocation!
- ⚠️ Choking hazard!**
Do not expose the product, especially the lens, to direct sunlight to avoid fire hazard
- ⚠️ Risk of product damage!**
Do not place in high temperature environment! Do not put night vision goggles in a car in hot weather or under the sun, and keep away from heat generating equipment. These can cause damage to telescope performance.
- ⚠️ Do not disassemble the product!**
without permission, if the product fails, please contact the dealer, if necessary, The dealer will contact the after-sales service center for maintenance.
- ⚠️ Please respect the privacy!**
of others, for example, do not use this product to peep into the lives of others.

[Instructions for Use]

- Night vision devices are precision opto-electronic instruments used to observe targets at night. They can operate in extremely dark environments.
- Night vision with built-in infrared illumination for use in pure darkness for supplemental illumination.
- When the environment is dark, turn on the auxiliary lighting, you can adjust the brightness of the auxiliary lighting source according to the distance of the observed objects. Night vision instrument using ultra-low illumination detector, when the use of the environment is not completely dark, you can't turn on the auxiliary light source, you only need to properly adjust the focal length of the objective lens, so that the object to be observed can be clear.

3

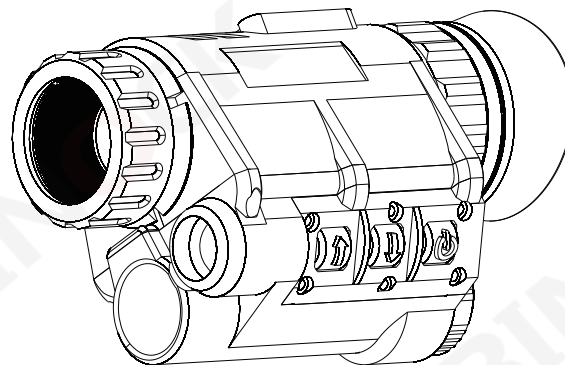

Products

【Name】 Helmet mounted night vision

【Model】 NVG30

[Performance Characteristics

- This product can be used in day and night, optical magnification of 1X, digital magnification of 4X, large 40° field of view.
- This product adopts 2K(2560*1440) ultra-low illumination detector, and you can turn on the motion mode at night to get 2K 40HZ delay-free images.
- In the total dark environment, this product can still observe the target without any infrared supplemental light, and can turn on the infrared light to get a better observation effect when there is no light at all. There are 4 color modes to choose from: color, night green, white phosphorus, and black and white.
- The equipment has a certain degree of intelligence, can be set to automatically adjust the brightness of the display, automatically adjust the intensity of the infrared lamp (adjusted according to the use of the environment)
- Power supply and battery life: This device uses one 18650 rechargeable lithium battery; the default battery life of this product is 5 hours, it can be used for 4 hours when only WIFI is turned on, and 3 hours when both WIFI and infrared light are turned on.
- This device has a built-in WIFI module, which can be connected with mobile devices to realize real-time image transmission, video recording, photo-taking, playback and other functions in the APP.
- This product is the best auxiliary tool for human vision extension, the top interface can be installed with many types of adapter brackets to match with different tipping frames, as well as to form a binocular use.

4

【Component Description】

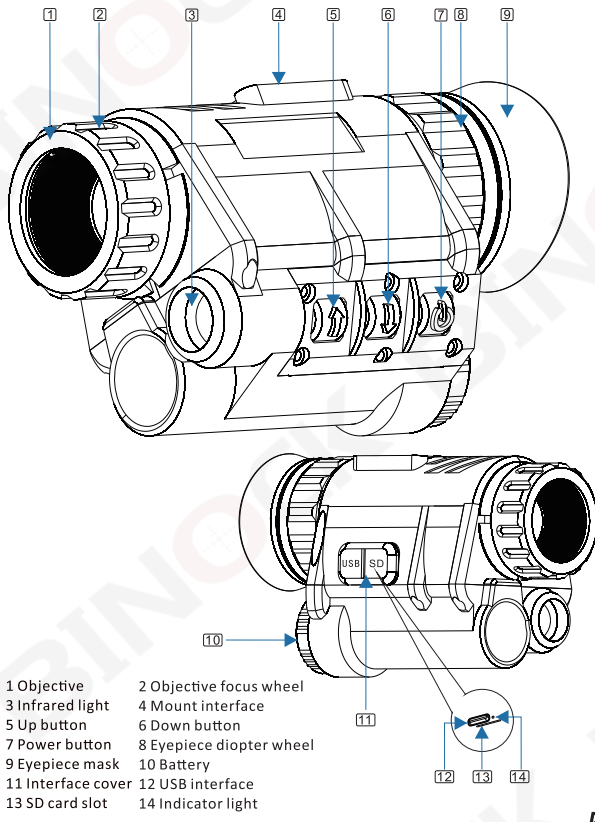

- | | |
|--------------------|--------------------------|
| 1 Objective | 2 Objective focus wheel |
| 3 Infrared light | 4 Mount interface |
| 5 Up button | 6 Down button |
| 7 Power button | 8 Eyepiece diopter wheel |
| 9 Eyepiece mask | 10 Battery |
| 11 Interface cover | 12 USB interface |
| 13 SD card slot | 14 Indicator light |

5

【Charging battery】

The battery of product is a 3.7V,18650 lithium battery ,it can provide more than 5 hours. Before using it for the first time, remember to charge the battery; Battery charging method:

- Open the battery cover;
- put the battery inward in ward, install the negative electrode outward in the battery compartment, and rotate the battery warehouse cover;
- The power adapter is connected to the Type-C-USB charging cable, and the other end is inserted into the port on the device;
- After the connection is successful, the power indicator on the device is lit with red. At this time, the  device will appear in the lower left corner of the open display screen;
- Press the switch button when normal charging, and turn off the device to shorten the charging time;

【Battery installed】

Open the battery cover, take a 18650 battery (at least 3.7V or more voltage), the negative pole of the battery inward into the battery compartment, tighten the battery cover, click the on button , from the eyepiece to observe whether the internal display is lit, lit that the battery is installed correctly; If, the display does not show anything, please make sure: 1: is the battery type 18650? 2: Is the battery orientation installed correctly? 3: Is the battery cover tightened? 4: Does the battery have sufficient charge?

After confirming that all the above four points are correct, turn on the machine again and test until the machine works properly.

【Power on】



- Open the objective lens cover.Main interface screen and icons
- Click the on/off button and look through the eyepiece.The in-unit display lights up and the display shows the figure at right(Icon shown, the machine enters normal operation.Icon Description:

6

【Shutdown】

Regardless of the state of the unit, press and hold the  button (3 seconds) to turn the unit off

【Targeted Observation】

- In the power-on state, the eyepiece is close to the eye to view the display, and the objective lens is aimed at the target to be observed,.
 - Adjust the eyepiece vision hand wheel to maximize the clarity of the text icons on the screen;
 - Adjust the focusing hand wheel of the objective lens to maximize the clarity of the observed target.
 - Up button  can realize digital magnification, the magnification range is 1~4X.
 - In different use environments, you need to adjust the brightness of the display and the intensity of the infrared light to get a better use experience;
 - When using at night, press and hold down the button  to enter night vision mode for better observation;
- Note: Do not have any objects in front of the IR lamp when focusing at night.

【Screen information】

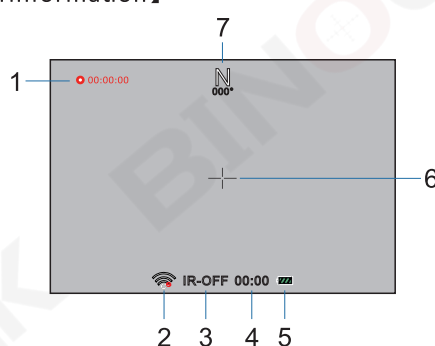

- | | | |
|-----------------|-------------------------|----------------------|
| 1: Video status | 2: WiFi status | 3: Night mode status |
| 4: Time | 5: Battery power status | 6: Cross Line |
| 7: gyroscope | | |

7

【Auto Mode】

- This device has a certain degree of intelligence, can be set to automatically adjust the brightness of the display, automatically adjust the intensity of the infrared lamp (according to the use of environmental adjustment).
- In the menu setting "LCD Brightness Adjustment", select Auto Brightness Setting and confirm (see LCD Brightness Adjustment for operation details);
- Select Auto On in the menu setting "IR Auto" and confirm (see P IR Auto for details);



【Motion Mode】

This device can switch between QHDP30 (2K-30HZ)/QHDP40 (2K-40HZ) resolutions, which is suitable for fast movement, allowing users to run up at night.

Select the QHDP30/QHDP30 setting in the menu setting "Resolution" and confirm (see P16 Resolution for details on operation);

【Menu Operation】

Most function settings are made in the menu.

- Press and hold the up button for  2 seconds, and the menu appears.
- On the screen where the menu appears, press and hold the Up button for  2 seconds and release the button, the menu will close.
- In menu operations, the Up and Down buttons are used to control the movement of the selection cursor bar between menu items. When the selection cursor bar is located at a menu item, press the On/Off button to confirm the selection.

8

【Detailed introduction of buttons】

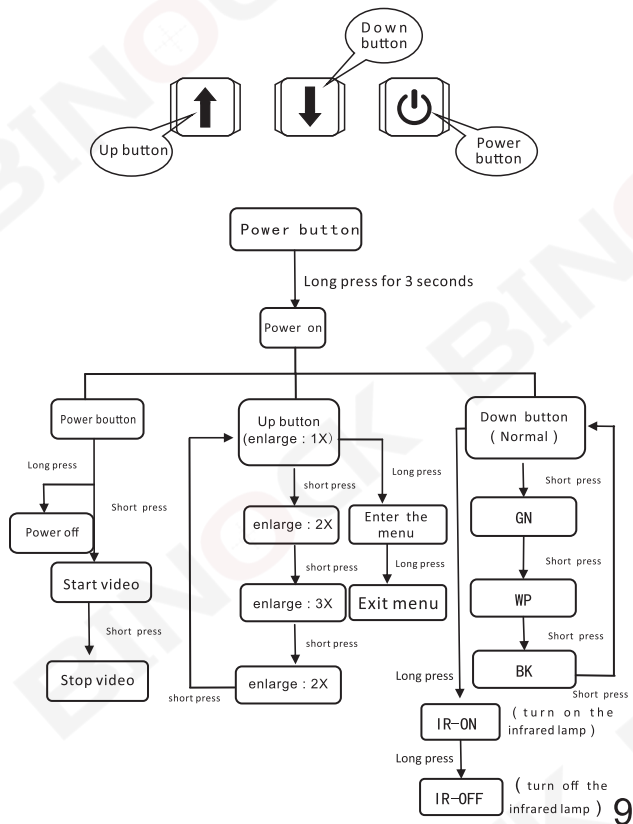

【Icon】

● Long press the up button for 2 seconds to open the menu, the default selection of "Icon" option, press the button to confirm to enter the sub-menu to select on/off the main interface icon, the best for two devices with dual vision.

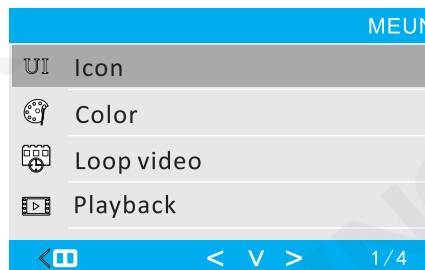

【Color】

● Long press the up button for 2 seconds to open the menu, press the up and down button selected "color" option, press the button to confirm the sub-menu to select "black and white, color, night green, white phosphorus" 4 color mode selection, the user according to the use of the environment and personal preference. Users choose according to the use of the environment and personal preferences.

Note: This function can be quickly switched by clicking Down button Quick Switch in the main interface;

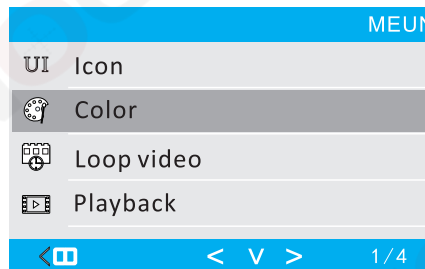

10

【Loop video】

● Long press the up button for 2 seconds to open the menu, press the up and down buttons select "loop recording" option, press the button to confirm to enter the sub-menu to select "off, 1 minute, 3 minutes, 5 minutes, 10 minutes" 5 kinds of options Recording duration, the user according to the use of the environment and personal preferences to choose.

Note: When the option "Off" is selected, the device will keep recording continuously, which may overwrite the previously stored files and fail to save;

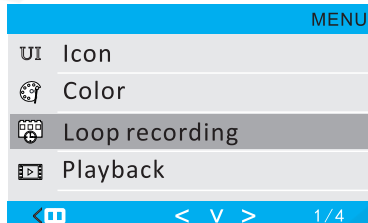

【Playback】

● Long press the up button for 2 seconds to open the menu, press the up and down buttons to select the "Playback" option, press the on/off button to confirm to enter the sub-menu to view the stored picture/video files, press the up and down buttons to select the video/picture you want to view, and then click on the confirmation button to enter the playback.

In the video playback interface: click Confirmation - Play/Pause, during playback Press Up/Down to adjust the fast forward and rewind speed, long press Up to exit playback.

When the video is not playing, long press the up button to open the setting sub-menu, there are four options to set the file: "Delete, Delete All, Video, Back";

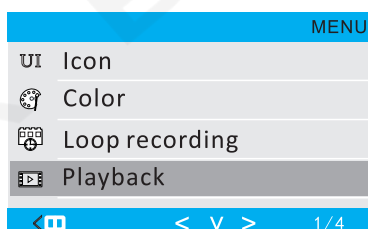

11

【WiFi】

● Long press the up button for 2 seconds to open the menu, press the up and down buttons to select the "WIFI" option, press the button to confirm to enter the sub-menu to select the "off, on" 2 choices.

Connection steps: 1 Open WIFI (WIFI icon at the bottom of the main interface shows open); 2 Connect WIFI with your mobile device (default account: NVG20 XXXXX, default password: 12345678); 3 Open the APP for transferring the real-time images, taking pictures, video recording, playback and other operations;

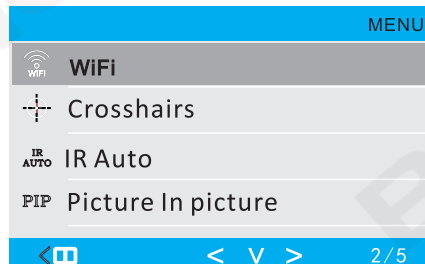

【Crosshairs】

● Long press the up button for 2 seconds to open the menu, press the up and down buttons select "crosshairs" option, press the button to confirm the sub-menu to select "off, on" 2 choices, choose to open the crosshairs will appear in the image! The crosshairs will appear in the center of the image to assist observation, users choose according to the use of the environment and personal preference.

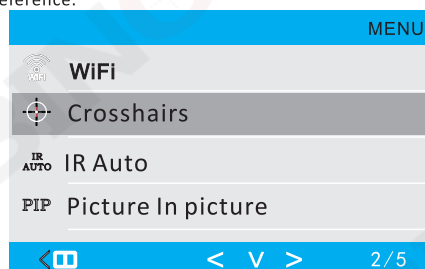

12

【IR Auto】

● Long press the up button for 2 seconds to open the menu, press the up and down buttons (↑ ↓) to select "IR Auto" option, press the (⏏) button to confirm the sub-menu to select "Auto Off, Auto On" 2 choices, after selecting Auto On, the device will After selecting auto on, the device will automatically adjust the intensity of infrared light (according to the use of environmental adjustment), the user according to the use of the environment and personal preferences to choose.

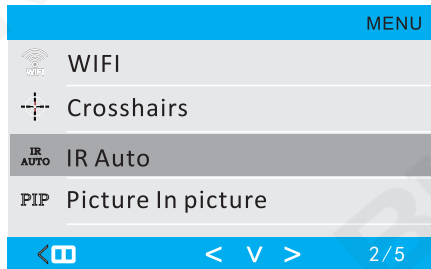

【Picture In picture】

● Long press the up button for 2 seconds to open the menu, press the up and down buttons (↑ ↓) to select "Picture In Picture" option, press the (⏏) button to confirm to enter the sub-menu to select the "off, on" 2 kinds of choices, choose to open, in the main interface, press the button (↑) will be change to the center of the region of the local zoom, the user according to the use of the environment and personal preferences to choose.

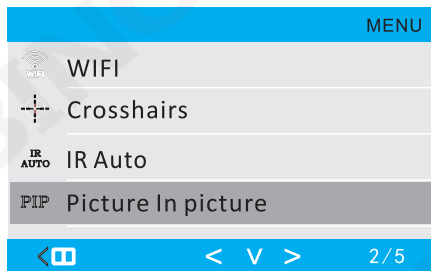

13

【LCD brightness】

Long press the up button for 2 seconds to open the menu, press the up and down buttons (↑ ↓) to select the "loop video" option, press the (⏏) button to confirm to enter the sub-menu to select the "automatic brightness, level 1, 2, 3, 4, 5" and other options, press the up and down buttons (↑ ↓) to switch the option screen brightness also changes according to the user to choose according to personal preferences. Press the up and down keys (↑ ↓) to switch the option when the screen brightness also changes, users choose according to the use of the environment and personal preferences.
Note: The screen brightness ranges from 1 to 5, with 5 being the brightest; when "Auto Brightness" is selected, the device will automatically adjust the intensity of the display (according to the usage environment);

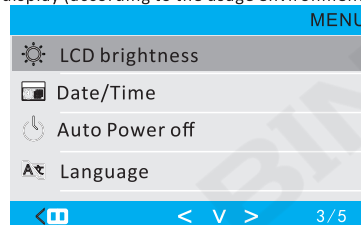

【Date/Time】

● Long press the up key for 2 seconds to open the menu, press the up and down buttons (↑ ↓) to select the "date/time" option, press the (⏏) button to confirm to enter the sub-menu, press the up and down keys (↑ ↓) to move to select a different value, press the confirmation key to switch the value, modify the value, long press the up button to switch all the values and save and exit.
Note: The device will automatically synchronize the time after connecting to the mobile device via WIFI; when the device is removed from the battery, the time will revert to the default initial time;

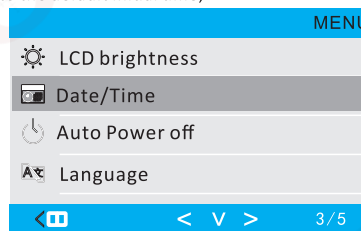

14

【Auto Power Off】

● Long press the up button for 2 seconds to open the menu, press the up and down buttons (↑ ↓) selected "Auto Power Off" option, press the (⏏) button to confirm the sub-menu to enter the selection of "off, 1 minute, 2 minutes, 3 minutes, 5 minutes, 10 minutes". 6 kinds of choices without any operation after the automatic shutdown time, the user according to the use of the environment and personal preferences to choose.

Note: When the option "Off" is selected, the device will continue to work until it runs out of power;

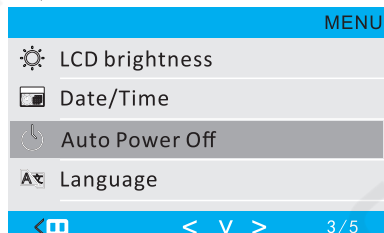

【Language】

● In the main interface, long press the up (⏏) button for 2 seconds to open the menu, press the up and down buttons (↑ ↓) to select "Language" option, press the on button to confirm to enter the sub-menu to select "English, Français, Español, Português, Deutsch, Italiano, Simplified Chinese, Traditional Chinese, Русский, Japanese" 10 menu languages, the user according to the use of the environment and personal preferences to choose.

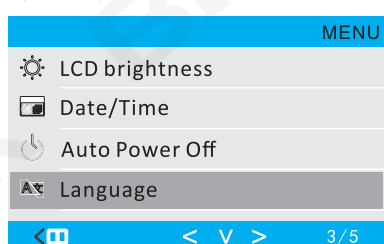

15

【Resolution】

● Long press the up button for 2 seconds to open the menu, press the up and down buttons (↑ ↓) to select the "resolution" option, press the (⏏) button to confirm to enter the sub-menu to select "QHDP30, QHDP40" two options, QHDP30 is for 30HZ image refresh rate, QHDP40 is for 40HZ image refresh rate - more suitable for fast motion. QHDP30 is for 30HZ image refresh rate, QHDP 40 is for 40HZ image refresh rate - more suitable for fast motion.

Note: The product will restart when the resolution is selected, and the WIFI transfer function will not be available when "QHDP40" is selected;

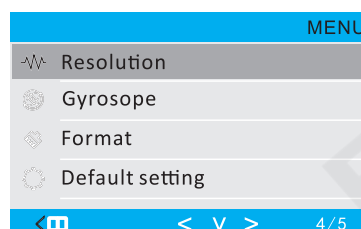

【Gyroscop】

● Long press and hold the up button for 2 seconds to open the menu, press the up and down buttons (↑ ↓) to select "Gyroscop" option, press (⏏) button to confirm to enter the sub-menu to select the "Calibration" option, click the confirmation button to enter the calibration interface, the main interface appears at the left and right ends of the calibration value, place the product on the horizontal desktop for 5-10S, the automatic calibration will be completed; The calibration is completed automatically. After the calibration values appear on the left and right side of the main interface, place the product on the horizontal desktop for 5-10S, then the automatic calibration will be completed; **Note:** Re-calibration is required only when the compass direction is found to be inaccurate after being affected by natural elements.

16

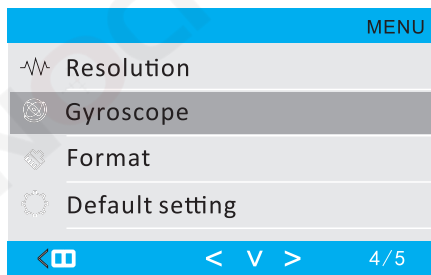

【Format】

●Long press the up button for 2 seconds to open the menu, press the up and down buttons (↑↓) select "format" option, press the (⏻) button to confirm the sub-menu to select "cancel, OK" option, after determining the memory card will be formatted to delete all the files on the card. All the files in the card will be formatted and deleted, users can choose according to the environment and personal preference;

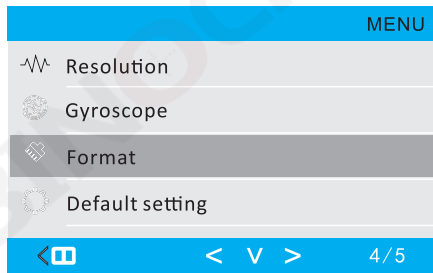

17

【Default setting】

●Long press the up button for 2 seconds to open the menu, press the up and down buttons (↑↓) selected "Default Settings" option, press (⏻) button to confirm the sub-menu to enter the "Cancel, OK" option, after determining the product settings will be restored to factory settings, users choose according to the use of the environment and personal preferences. After confirming, the product settings will be restored to the factory settings, users can choose according to the use of the environment and personal preferences;

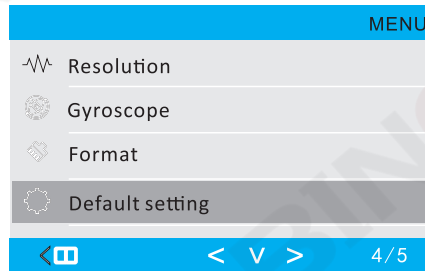

【Version】

●Long press the up key for 2 seconds to open the menu, press the up and down keys (↑↓) to select the "version" option, press the on/off key to confirm to enter the sub-menu, displaying the current version of the software information, and then press the (⏻) key again to return to the menu.



18

【Basic Parameters】

Category	Item	Parameter
Product Main Parameters	Magnification	1-4X
	Objective Diameter	20mm
	resolution (of a photo)	2560*1440
	field of view	40°
	Maximum effective distance under starlight	0.2-300m
	Multi-language support	10 types
	Color Mode	Color/Black & White/Fluorescent Green/White Phosphorus
power supply	operating voltage	3.7V DC
	Replaceable batteries	Rechargeable lithium battery 18650
	Charging Power	110-220V Adapter
other than	Dimensions (LxWxH)	110x80x57mm
	protection class	Ip67
	Weight	245g

19

【Standard configuration】

Name	quantity
Portable velvet bag	1
External power adapter	1
Type-C data cable	1
User manual	1
Battery	1
Objective polishing cloth	1
Colorful box	1

20

【Firmware Update】

Please contact the purchasing merchant for updates and instructions.

【Maintenance and cleaning】

It is recommended to maintain the product appropriately to ensure its service life. Attempting to disassemble or repair the equipment will void the warranty.

Suggest when there are stains on the display screen, objective lens filter cover, and objective lens of this machine. To observe the sound, first blow away the dust and debris on the optical components, and then use a mirror. Clean the lens with a head cleaning cloth. To remove oil stains or dry water spots, please use a mirror. Dip a small amount of denatured alcohol on a cloth or cotton swab.

【Trouble shooting】

Do not return the product without prior authorization. Doing so may result in multiple Loss of the product due to any reason, i.e. sending it to the wrong address and related Unexpected package for other issues;

◆ This unit will not turn on:

1. This product uses a special battery, please be sure to use the factory-configured battery and charger;

2. Check if the battery power is sufficient. If necessary, reinstall the battery;

◆ Infrared illuminator cannot play:

Press  the button to enter the night vision mode, adjust the brightness of the infrared light, if not detected;

If the infrared light changes, the device may need to be returned for repair;

◆ Image is darker:

Make sure to open the filter cover on the objective and turn on the IR illuminator. adjust accordingly;

Display brightness and IR illuminator brightness for bright and clear images;

◆ There are bright spots or black spots on the display

1. The dots appearing on the display are caused by the sensor production technology, not a defect.

◆ The image is out of focus:

1. Make sure there is no dust or condensation on the objective or eyepiece;

2. Make sure to adjust the eyepiece diopter settings for your specific vision until you can see the product clearly; content on the internal display of the product;

3. After making sure to see the contents of the display clearly, adjust the focusing handwheel on the side of the objective lens; Adjust focus for different viewing distances;

◆ Image flickering:

This is common if the unit is looking at or pointed in the direction of a bright light source. please stand,

That is, stop looking at bright light sources. If blinking under normal viewing conditions, then it may be caused by low battery power, please charge it in time.

The device needs to be returned for repair;

21

【Maintenance】

Proper maintenance of the product is recommended to ensure longevity. Attempt to disassemble or repair the device; will void the warranty. It is recommended that when the unit becomes dirty, wipe it with a dry or slightly damp cloth; Wipe clean. Blow dust and debris off all optics, then use the lens; Clean the lens with a cleaning cloth. To remove oily or dry water spots, use a lens cloth or cotton

The sign is dipped in a small amount of denatured alcohol. Clean and dry the lens surface. Finally, again;

Exhale to clean the lens. No further maintenance is required;

【Disposal of waste】



Properly dispose of packaging materials by category, such as paper or cardboard; dispose of equipment in accordance with current regulations. You can learn more about proper disposal of waste from your local waste disposal service or the Environmental Authority.

【Precautions for returning goods】

◆ Ensure that the product is properly packaged and properly protected before transportation/ mailing; Try to use the original packaging as much as possible.

◆ Please attach the purchase voucher and warranty card, along with a brief explanation of the product malfunction, return to the recipient, contact information, and detailed address.



Attention: Dust and moisture proof!

After using waterproof products in high humidity environments, store them

after the moisture has dissipated and the products have dried;

Non waterproof products should not be used in high humidity environments, otherwise it may cause damage to product performance;

After using at the seaside, gently soak a clean soft cloth with water and wipe

off any remaining salt on the surface of the mirror body;

If not used for a long time, please thoroughly clean the lens and body, place

the product in the mirror bag, place it in a well ventilated and dry place, and add an appropriate amount of desiccant to prevent moisture;

22

